



# 乙盛精密工業股份有限公司

## ESON Precision Ind. Co., Ltd.



ESON-KY ( 5243 )

報告人：蕭伊宏



# 投資安全聲明

ESON

除簡報內所提供之歷史信息外，簡報事項係預測性陳述，受到風險及不確定性因素影響，可能造成實際結果與陳述內容不符，這些不確定的因素包括：受到競爭性產品及定價的影響、新專案或新技術是否及時導入、新產品大量量產之能力、產業及市場是否供給過剩、製造產能可得利用情況、終端市場之財務穩定性，及國際匯率或其他風險等。

# Agenda

ESON



ESON

乙盛公司簡介



公司營運



未來展望



Q & A



# ESON

## ESON 公司簡介

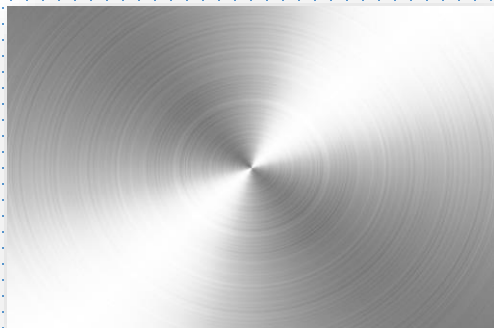



- ❑ 成立時間：1987年
- ❑ 董事長：蔡嘉祥
- ❑ 總經理：蕭伊宏
- ❑ 資本額：NTD 16.85 億元
- ❑ 集團員工人數：約6,000人

- ❑ 主要營業項目：  
機構類產品設計與製造
  - 汽車產品
  - 網雲產品
  - 消費性產品

## 成長期

- 2015年 接獲汽車機構件生產
- 2016年 于馬來西亞設立二廠
- 2019年 墨西哥擴廠
- 2020年 于越南設廠
- 2020年 馬來西亞一廠擴廠

## 發展期

- 2009年 承接大型美系伺服器訂單
- 2012年 于墨西哥設廠
- 2013年 于馬來西亞設立一廠
- 2013年 于臺灣挂牌上市

## 扎根期：

- 2001年 新設昆山工廠
- 2004年 承接汽車模具
- 2006年 新增成型注塑業務
- 2006年 承接日系遊戲機訂單

## 創立期：

- 1987年 成立，從事模具加工業務
- 1995年 承接大型日系模具開發



## Milestone

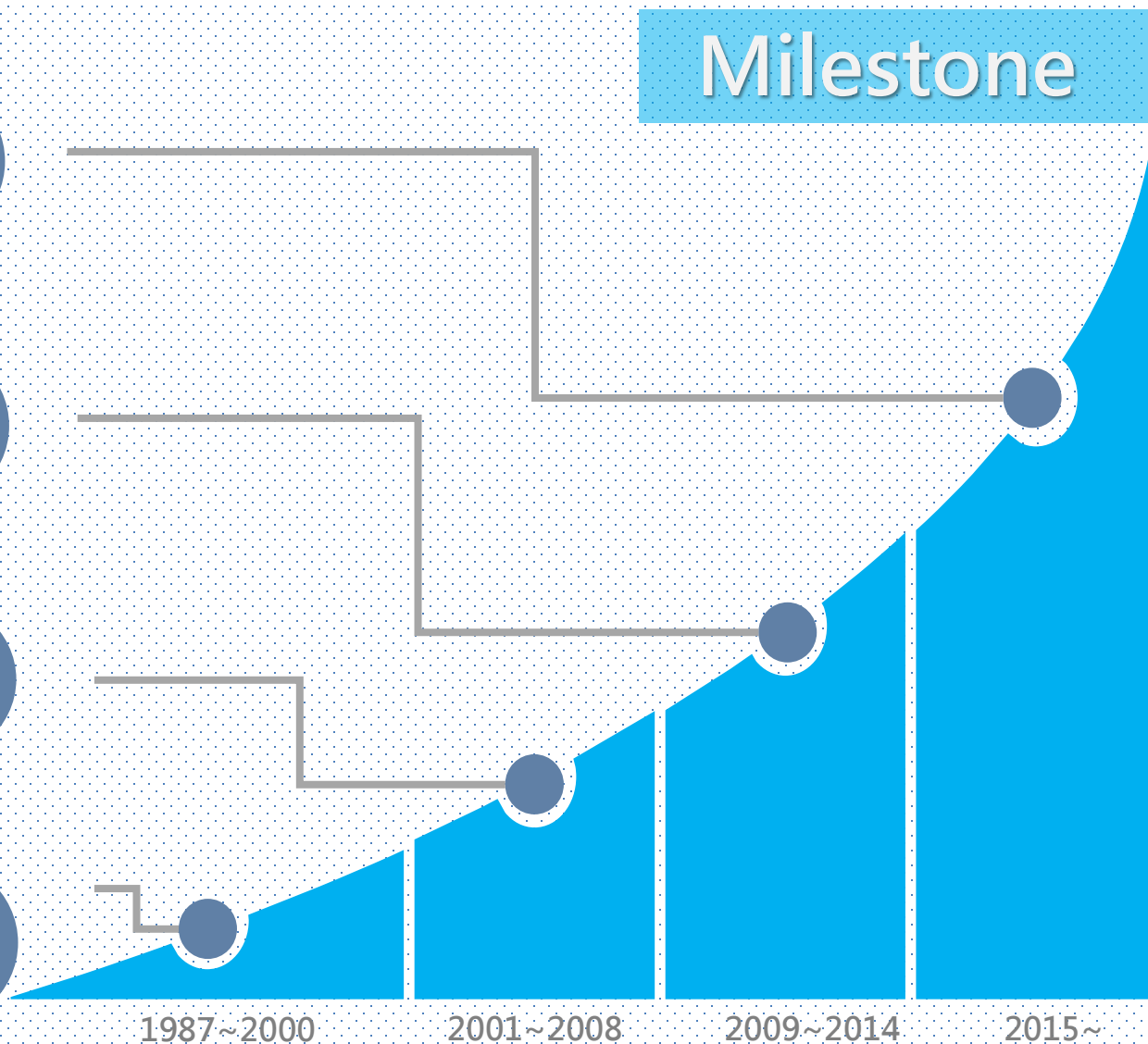

# 全球布局

ESON

昆山乙盛  
ESON Kunshan



烟臺正乙  
ESON Yantai



東莞乙宏  
ESON Dongguan



台灣運營中心  
臺北  
ESON Taipei



(Under Construction)



越南乙盛(廣寧)  
Tỉnh Quảng Ninh  
ESON Vietnam



馬來西亞一廠  
Bangi  
ESON Malaysia I



馬來西亞二廠  
Batu Pahat  
ESON Malaysia II



墨西哥廠  
Tijuana  
ESON Mexico



## 內側部件



車內側塑件



座椅部件



音響機構件



引擎室結構件

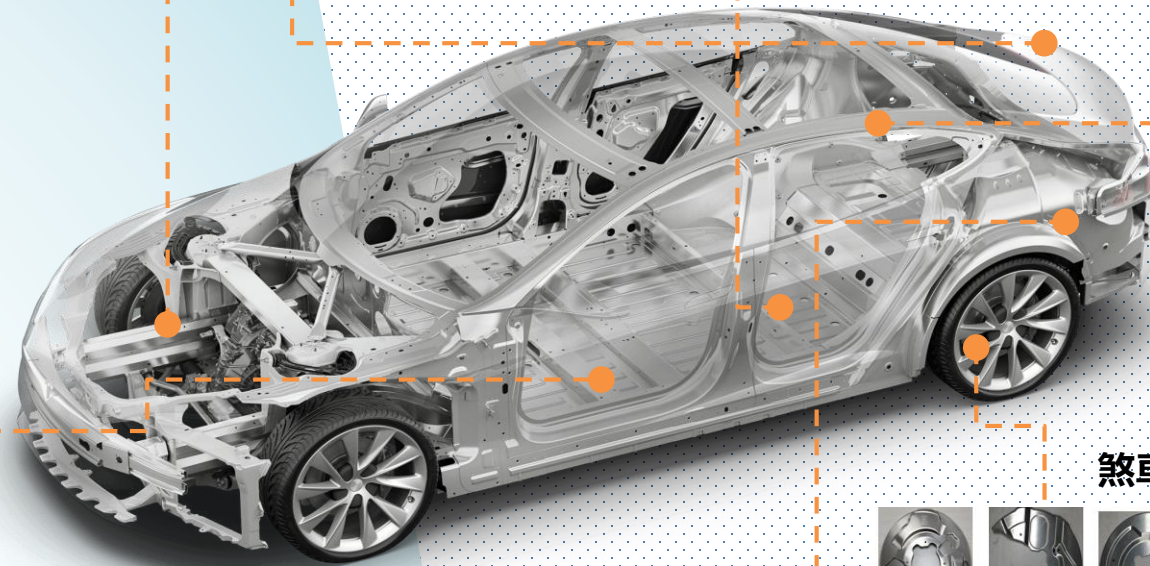

## 車身部件

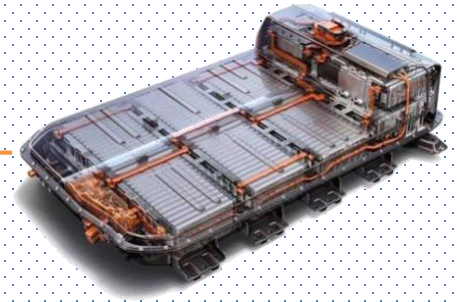

電池機構組件

車架部件

煞車防塵蓋

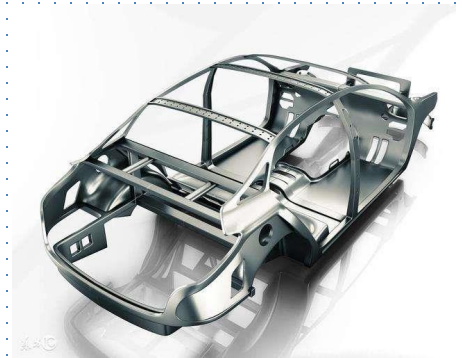





# 網雲產品

# ESON



# 消費性產品

# ESON



A background graphic featuring a complex network of blue nodes and lines, overlaid on a light blue grid of hexagons. The nodes vary in size and are connected by thin lines, creating a web-like structure.

# ESON

## 公司營運

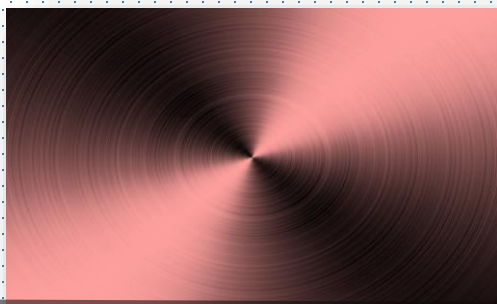

# 營運績效

# ESON

幣別：新台幣百萬元

ESON	2016年度		2017年度		2018年度		2019年度		2019年度1-9月		2020年度1-9月	
資本額	1,735		1,735		1,735		1,685		1,685		1,685	
銷貨收入淨額	10,862	100%	10,877	100%	10,299	100%	10,102	100%	7,679	100%	6,786	100%
銷貨毛利	1,428	13.10%	1,673	15.40%	1,447	14.00%	1,661	16.40%	1,250	16.28%	1,193	17.59%
稅前利益	437	4.00%	490	4.50%	487	4.70%	663	6.50%	532	6.90%	458	6.75%
稅後淨利	358	3.30%	432	4.00%	375	3.60%	499	4.90%	401	5.20%	341	5.03%
EPS (元)	2.18		2.5		2.14		2.96		2.38		2.02	

# 主要營運指標

ESON

幣別：新台幣百萬元

## 銷貨毛利

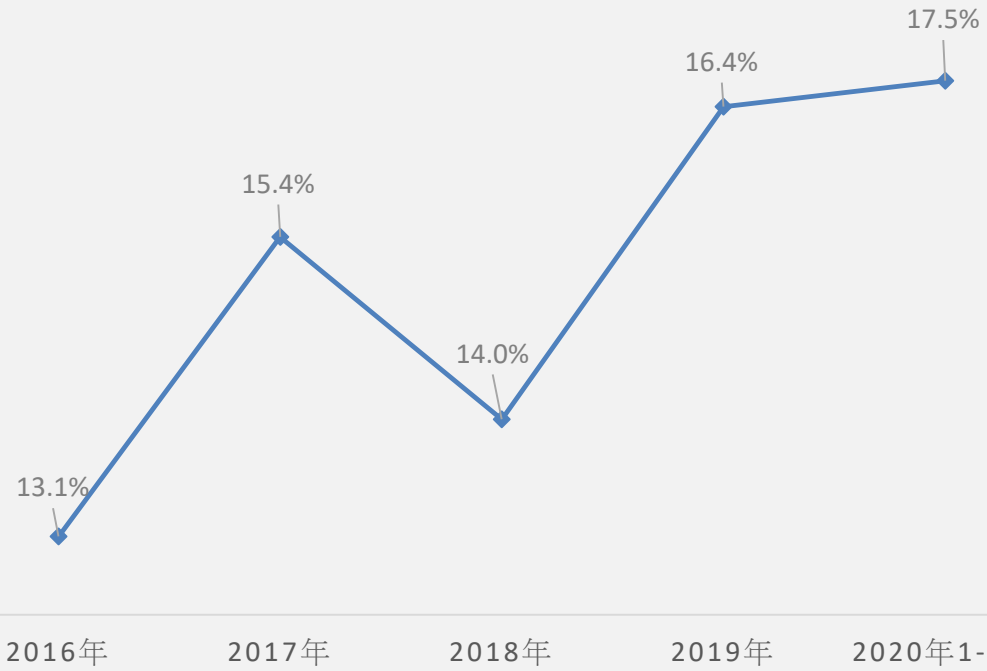

## 稅後淨利

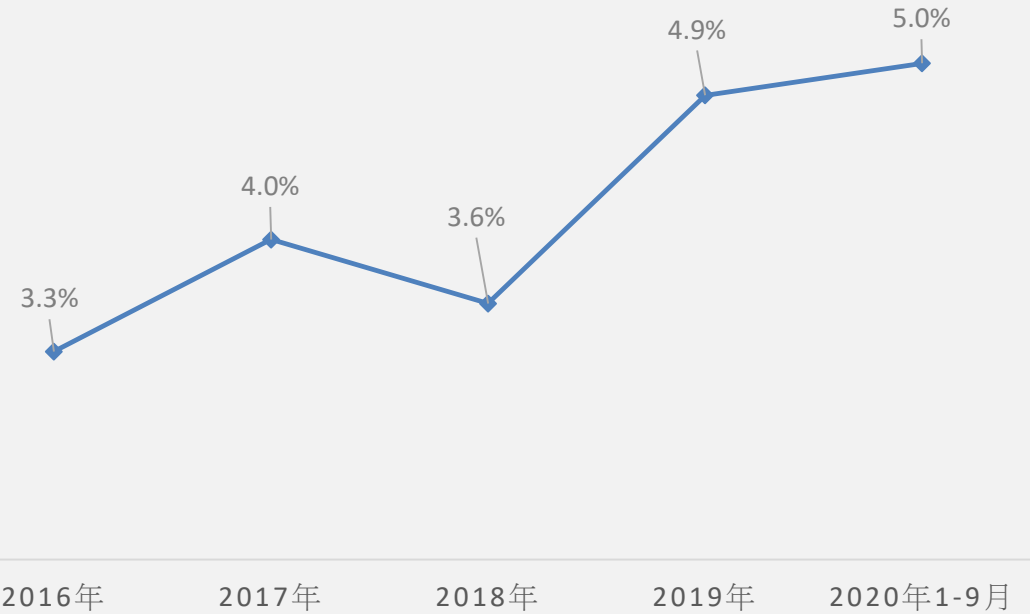

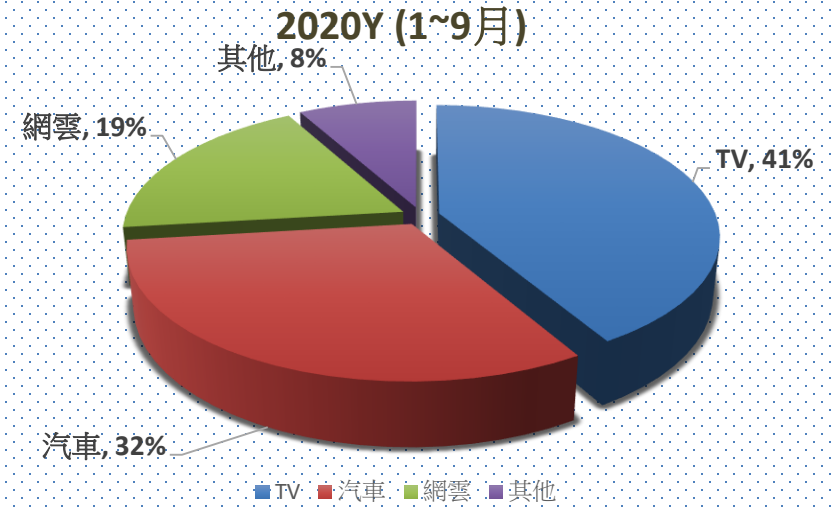
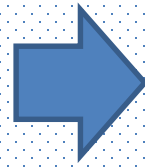
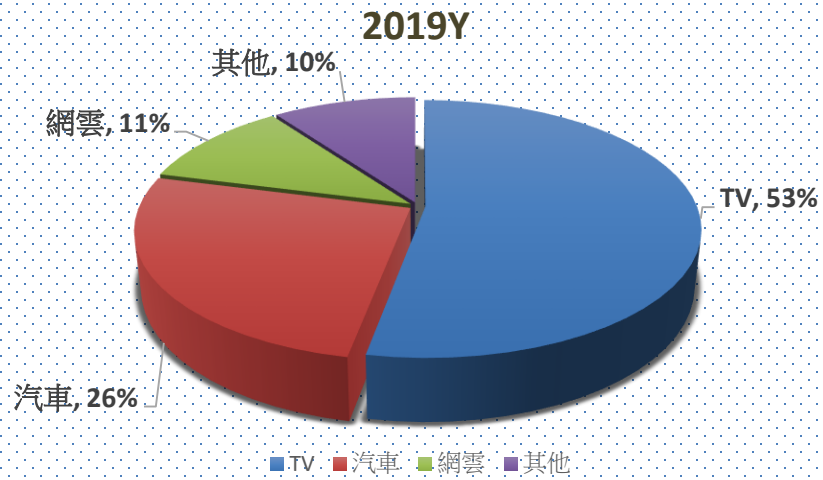

## 2019年~2021年產品營收分佈

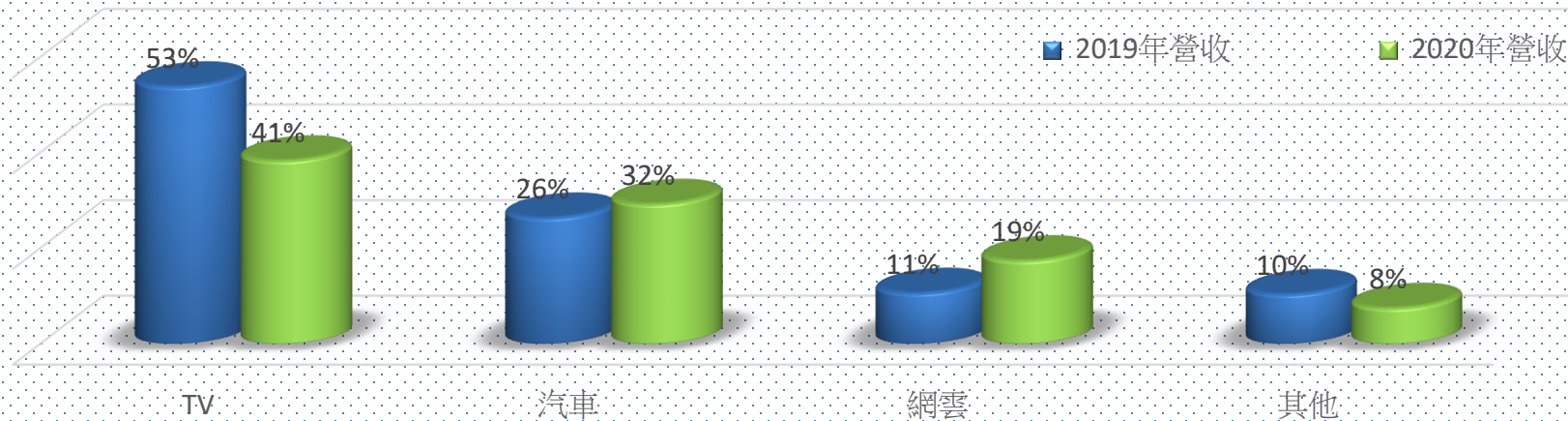



# ESON

## 未來展望

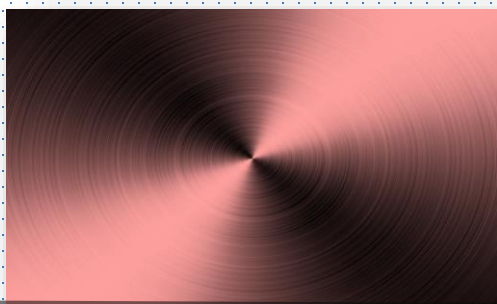
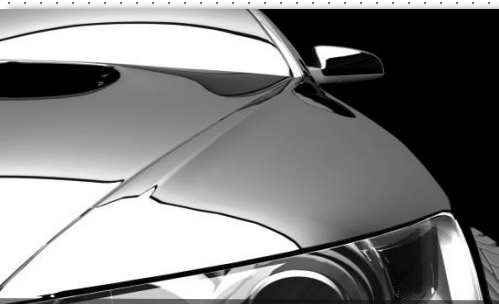

## 車載塑膠件製造工藝延伸

- 發泡成型技術
  - 座椅件總成 / 扶手件總成
- 熱壓成型
  - 應用於車廂內部飾件

## 單件部品逐步躍升為總成件

- 車門內側總成
  - 車尾門內側總成
  - 電動汽車 電池包機構總成







# 網雲產品營運策略

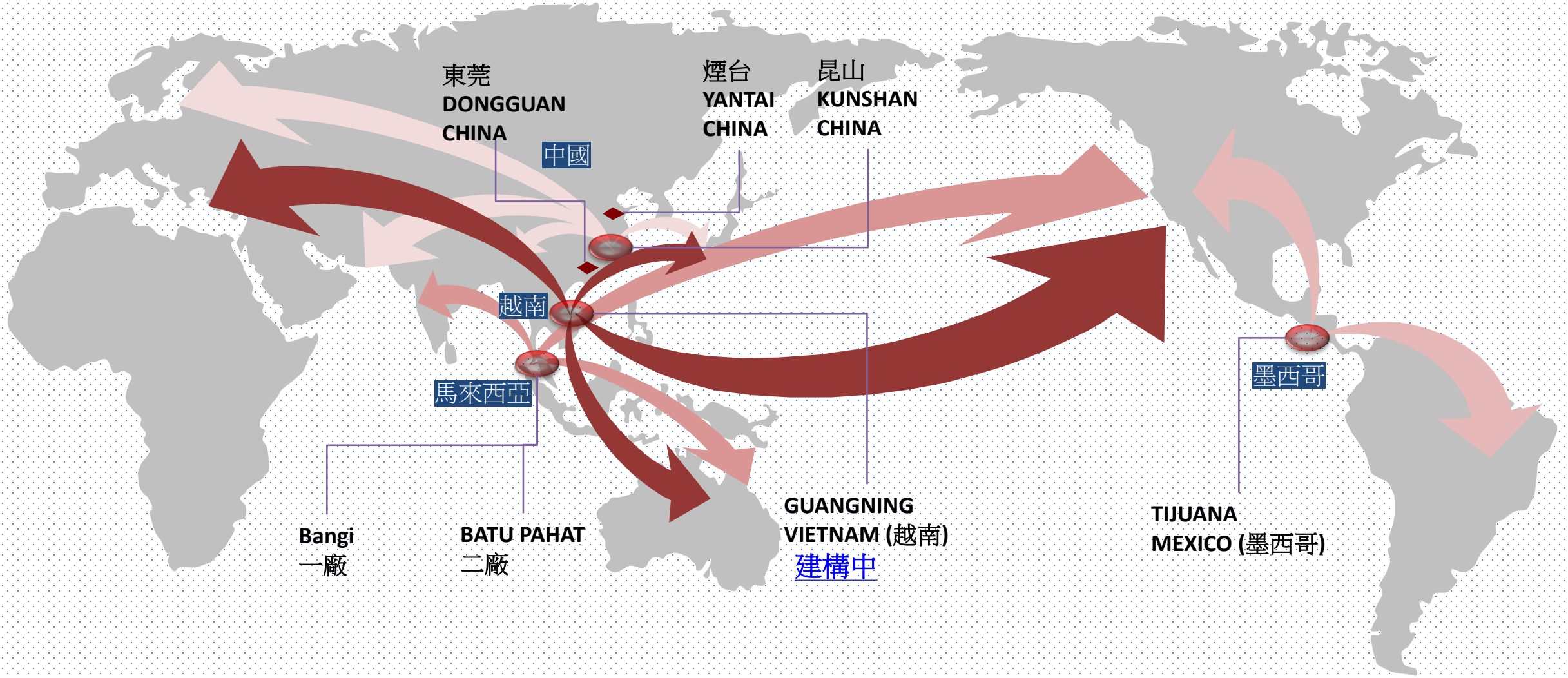

強化全球佈局的優勢，爭取調整佈局的客戶

# 擴廠計畫 - 墨西哥廠區

ESON



2020 擴充區域  
• 土地: 21,000 m<sup>2</sup>



- ❖ 土地面積由10.15萬m<sup>2</sup> 增加為12.25萬m<sup>2</sup>
- ❖ 擴充廠區預定在2020年11月竣工

# 擴廠計畫 – 馬來西亞(I)廠區



- ❖ 新增廠房面積為8640m<sup>2</sup>
- ❖ 擴充廠房預定在11月底投產

# 新廠投資 - 越南

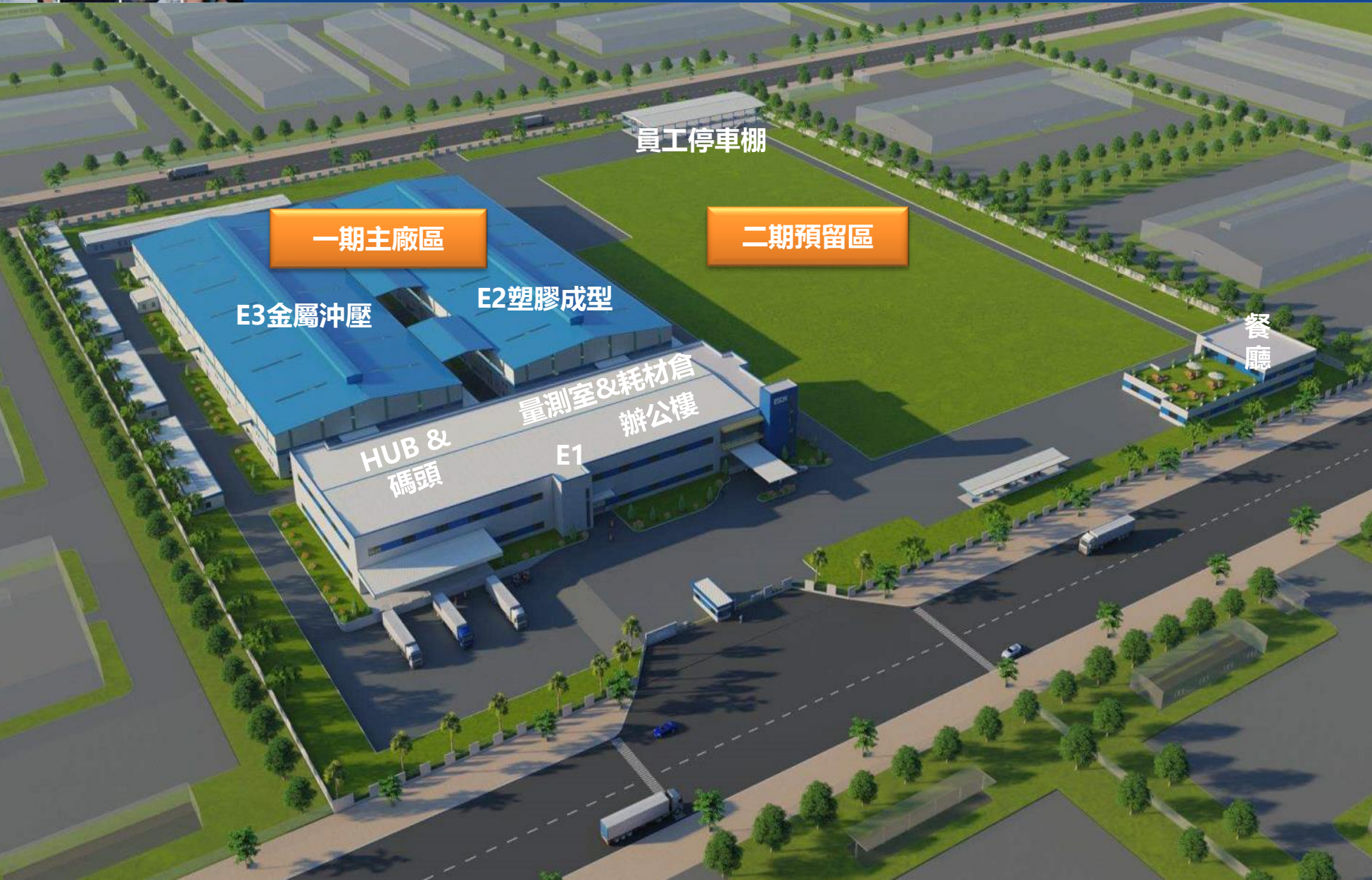

土地面積：  
□ 100,000m<sup>2</sup>

產品營運計畫：  
□ 電視機產品生產  
□ 伺服器產品生產

建廠計畫：  
□ 2021 2月試產

ESON

A close-up photograph of two people in business suits shaking hands. The hands are clasped together in a firm grip, symbolizing agreement or partnership. The background is blurred, focusing attention on the handshake.

THANK YOU

ESON Precision Ind. Co., Ltd.